

EC3500
Ruggedized Embedded System
with NVIDIA® Jetson AGX Orin™ module

User's Manual

Document Version 1.0
(Jun. 2024)



Copyright

© 2024 IBASE Technology, Inc. All rights reserved.

No part of this publication may be reproduced, copied, stored in a retrieval system, translated into any language or transmitted in any form or by any means, electronic, mechanical, photocopying, or otherwise, without the prior written consent of IBASE Technology, Inc. (hereinafter referred to as “IBASE”).

Disclaimer

IBASE reserves the right to make changes and improvements to the products described in this document without prior notice. Every effort has been made to ensure the information in the document is correct; however, IBASE does not guarantee this document is error-free.

IBASE assumes no liability for incidental or consequential damages arising

from misuse or inability to use the product or the information contained herein, and for any infringements of rights of third parties, which may result from its use.

Trademarks

All the trademarks, registrations and brands mentioned herein are used for identification purposes only and may be trademarks and/or registered trademarks of their respective owners.

Compliance



The product described in this manual complies with all applicable European Union (CE) directives if it has a CE marking. For systems to remain CE compliant, only CE-compliant parts may be used. Maintaining CE compliance also requires proper cable and cabling techniques.



This product has been tested and found to comply with the limits for a Class B device, pursuant to Part 15 of the FCC Rules. These limits are designed to provide reasonable protection against harmful interference in a residential installation. This equipment generates, uses and can radiate radio frequency energy and, if not installed and used in accordance with manufacturer's instructions, may cause harmful interference to radio communications.

WEEE



This product must not be disposed of as normal household waste, in accordance with the EU directive of for waste electrical and electronic equipment (WEEE - 2012/19/EU). Instead, it should be disposed of by returning it to a municipal recycling collection point. Check local regulations for disposal of electronic products.

Green IBASE



This product complies with the current RoHS directives restricting the use of the following substances in concentrations not to exceed 0.1% by weight (1000 ppm) except for cadmium, limited to 0.01% by weight (100 ppm).

- Lead (Pb)
- Mercury (Hg)
- Cadmium (Cd)
- Hexavalent chromium (Cr6+)
- Polybrominated biphenyls (PBB)
- Polybrominated diphenyl ether (PBDE)

Important Safety Information

Carefully read the following safety information before using this device.

Setting up your system:

- Put the device horizontally on a stable and solid surface.
- Do not use this product near water or any heated source.
- Leave plenty of space around the device and do not block the ventilation openings. Never drop or insert any objects of any kind into the openings.
- Use this product in environments with ambient temperatures between 0°C and 60°C.

Care during use:

- Do not place heavy objects on the top of the device.
- Make sure to connect the correct voltage to the device. Failure to supply the correct voltage could damage the unit.
- Do not walk on the power cord or allow anything to rest on it.
- If you use an extension cord, make sure the total ampere rating of all devices plugged into the extension cord does not exceed the cord's ampere rating.
- Do not spill water or any other liquids on your device.
- Always unplug the power cord from the wall outlet before cleaning the device.
- Only use neutral cleaning agents to clean the device.
- Vacuum dust and particles from the vents by using a computer vacuum cleaner.

Product Disassembly

Do not try to repair, disassemble, or make modifications to the device. Doing so will void the warranty and may result in damage to the product or personal injury.



CAUTION

A Lithium-type battery may be provided for uninterrupted backup or emergency power.

Replace only with the same or equivalent type recommended by the manufacturer. Dispose of used batteries by observing local regulations.

Warranty Policy

- **IBASE standard products:**

24-month (2-year) warranty from the date of shipment. If the date of shipment cannot be ascertained, the product serial numbers can be used to determine the approximate shipping date.
 - **3rd-party parts:**

12-month (1-year) warranty from delivery for 3rd-party parts that are not manufactured by IBASE, such as CPU, CPU cooler, memory, storage devices, power adaptor, display panel and touch screen.
- * PRODUCTS, HOWEVER, THAT FAIL DUE TO MISUSE, ACCIDENT, IMPROPER INSTALLATION OR UNAUTHORIZED REPAIR SHALL BE TREATED AS OUT OF WARRANTY AND CUSTOMERS SHALL BE BILLED FOR REPAIR AND SHIPPING CHARGES.

Technical Support & Services

1. Visit the IBASE website at www.ibase.com.tw to find the latest information about the product.
2. If you encounter any technical problems and require assistance from your distributor or sales representative, please prepare and send the following information:
 - Product model name
 - Product serial number
 - Detailed description of the problem
 - Error messages in text or screenshots if any
 - The arrangement of the peripherals
 - Software used (such as OS and application software)
3. If repair service is required, please download the RMA form at <http://www.ibase.com.tw/english/Supports/RMAService/>. Fill out the form and contact your distributor or sales representative.

Table of Contents

Compliance	iii
Important Safety Information	v
CAUTION	v
Warranty Policy	vi
Technical Support & Services	vi
Chapter 1 General Information	1
1.1 Introduction.....	2
1.2 Features.....	2
1.3 Packing List	2
1.4 Specifications	3
1.5 Product View	5
1.6 Dimensions.....	7
Chapter 2 Hardware Configuration	8
2.1 Installations.....	9
2.1.1 Mounting Installation	9
2.1.2 HDMI Type-A Connector	10
2.1.3 DC Power Input Connector.....	10
2.1.4 Dual USB 3.2 Gen1 Type-A Connector.....	11
Chapter 3 Software Setup	17
3.1 Software/BSP Installation	18
3.2 Recovery Mode.....	18

Chapter 1

General Information

The information provided in this chapter includes:

- Features
- Packing List
- Specifications
- Product View
- Dimensions

1.1 Introduction

EC3500 is NVIDIA Jetson AGX Orin 64GB module delivers up to 275 TOPS of AI performance with power configurable between 15W and 60W.



1.2 Features

- Supports NVIDIA® Jetson AGX Orin™ 32GB/64GB module
- Wide Power Input Range 9 to 36VDC
- 1 x B-Key/1 x E-Key/1 x M-Key slot
- Operating Temperature -0 ~ 50 °C

1.3 Packing List

Your product package should include the items listed below.

- NVIDIA® Jetson™ AGX Orin series 32GB/64GB module
- Carrier board

The user's manual can be downloaded from the IBASE website.

1.4 Specifications

Product Name	EC3500
System Motherboard	NVIDIA® Jetson AGX ORIN 32GB/64GB SOM + Carrier Board
System	
Operating System	<ul style="list-style-type: none"> • Ubuntu 20.04
CPU Type	EC3500-32: 8-core NVIDIA Arm® Cortex A78AE v8.2 64-bit CPU 2MB L2 + 4MB L3 EC3500-64: 12-core NVIDIA Arm® Cortex A78AE v8.2 64-bit CPU 3MB L2 + 6MB L3
Memory	<ul style="list-style-type: none"> • System memory: 32/64 GB 256-bit LPDDR5 204.8
Storage	<ul style="list-style-type: none"> • 64 GB eMMC 5.1
Display	<ul style="list-style-type: none"> • HDMI 2.1 Type A
Network	1x RJ-45 GbE port 1x RJ-45 10GbE port
Power Supply	DC-in 9 to 36 VDC
Watchdog Timer	Yes (256 segments, 0, 1, 2...128 secs)
Dimensions (W x H x D)	150mm (W) x 125mm (D) x 70mm (H)5
RoHS	Yes
Certification	CE, FCC Class B
I/O Ports	
DC Jack	1 x 12V-24V DC jack
Display	1 x HDMI2.0a (up to 4K resolution)
LAN	1 x RJ45 GbE LAN 1 x RJ-45 10GbE port
USB	<ul style="list-style-type: none"> • 2 x USB 3.2 Gen1 Type-A • 1x USB 3.2 Gen2 Type-C • 1x USB 2.0 Type-C (OTG)
Expansion Slots	<ul style="list-style-type: none"> • 1 x M.2 E-Key 2230 (PCIe/USB2.0): Support WIFI/BT/GPS function • 1 x M.2 M-Key 2280: Support NVMe Storage • 1 x M.2 B-Key 3042/3052 (LTE/5G - USB3) w/ micro sim holder: cellular function • 1 x SIM Card Slot • 1 x MicroSD Slot
MISC. Function	<ul style="list-style-type: none"> • 1 x Recovery button • 1 x Reset button

Environment	
Operating Temperature	0 ~ 50 °C (32 ~ 140 °F)
Relative Humidity	10 ~ 90 %, non-condensing

All specifications are subject to change without prior notice.

1.5 Product View

I/O View

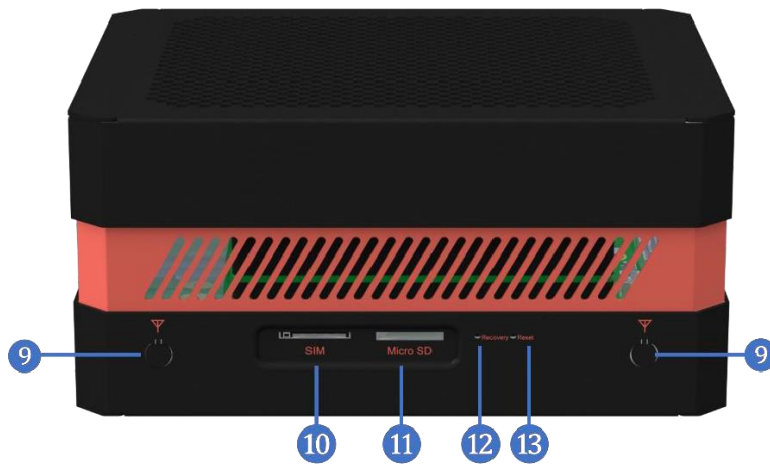
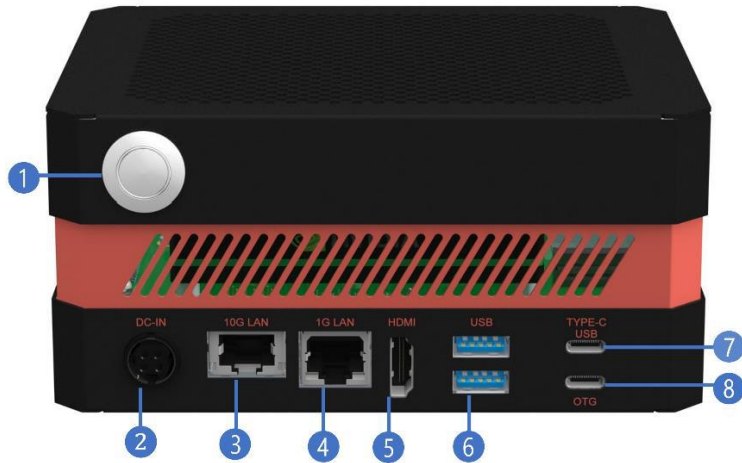

No.	Name	No.	Name
1	Power On/Off Button	8	USB 2.0 Type-C (OTG)
2	DC-in Jack	9	Antenna Holes
3	10G GbE LAN Port	10	SIM Card Slot
4	GbE LAN Port	11	MicroSD Slot

5	HDMI 2.1 Type A	12	Recovery button
6	USB 3.2 Gen1 Type-A	13	Reset button
7	USB 3.2 Gen2 Type-C	14	

DIN Rail Mounting View (Optional)



1.6 Dimensions

Unit: mm

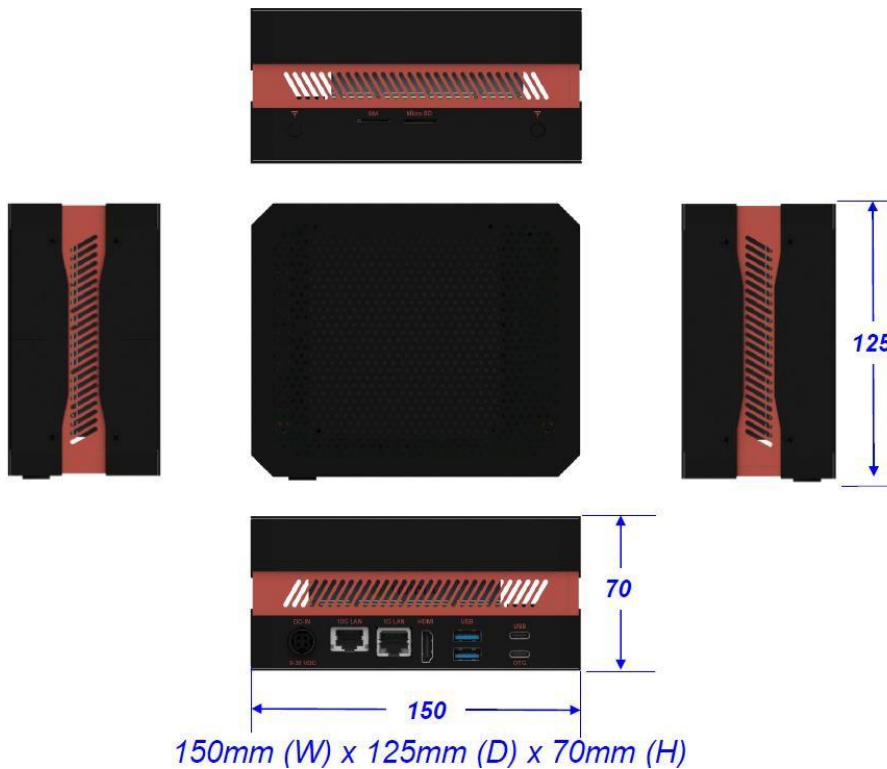

Chapter 2

Hardware Configuration

This section contains general information about:

- Installations
- Jumper and connectors

2.1 Installations

Before installing the M.2, wireless, SIM card or any other module into the device, loosen the 8 screws as shown below to remove the device cover.

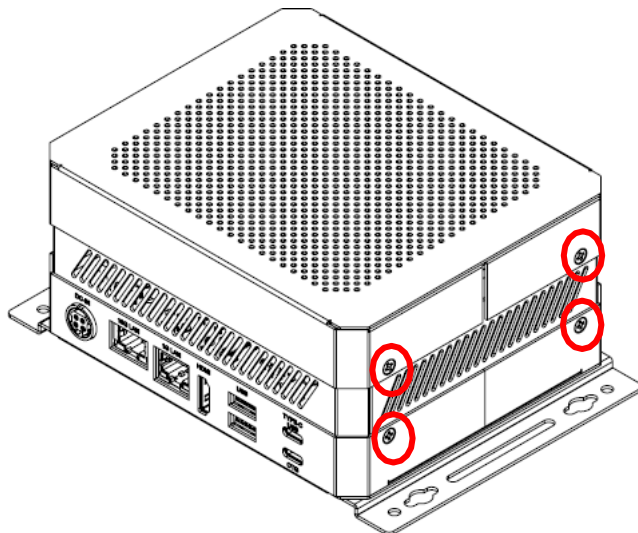

2.1.1 Mounting Installation

Requirements

Before mounting the system, ensure that you have enough room for the power adaptor and signal cable routing, and have good ventilation for the power adaptor. The method of mounting must be able to support weight of the device plus the weight of the suspending cables attached to the system. Use the following methods for mounting the device:

Wall Mounting Installation

1. Turn the device upside down.
Attach the wall-mount kit to the device using the supplied 4 screws.
2. Prepare at least 4 screws (M3) to install the device on the wall.

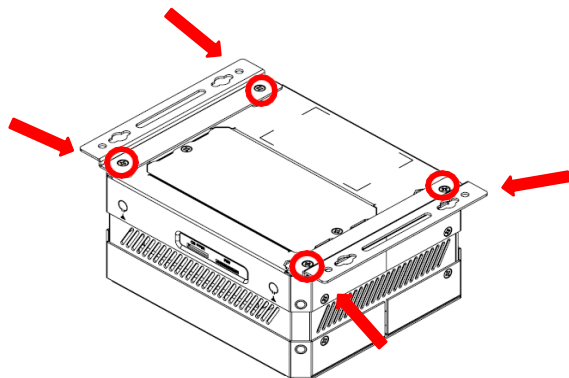

2.1.2 HDMI Type-A Connector



Item	Description
Location	CN8
Type	HDMI Type-A female connector
Pinout	Please refer to HDMI Type-A Standard

2.1.3 DC Power Input Connector



Item	Description
Location	CN12
Type	4-Pin Male DC Power Connector
Pinout	Please refer to DC Jack Standard

Pin	Signal Name	Pin	Signal Name
1	VIN	2	GND
3	VIN	4	GND

2.1.4 Dual USB 3.2 Gen1 Type-A Connector



Item	Description
Location	CN11
Type	Type-A USB connector
Pinout	Please refer to USB Standard

2.1.7 OTG Type-C / USB 3.2 Gen2 Type-C



Item	Description
Location	CN10
Type	Dual USB TYPE-C connector
Pinout	Please refer to USB standard
Notes	#1 OTG Type-C Port #2 USB 3.2 Gen2 Type-C

2.1.8 Gigabit Ethernet Connector



Item	Description
Location	CN9
Type	RJ-45 connector
Pinout	Please refer to Ethernet standard
Notes	LED Static ON: LAN Link is active. LED Blinking: Data is being transmitted. LED Static OFF: LAN Link is inactive

2.1.9 10 Gigabit Ethernet Connector



Item	Description
Location	CN7
Type	RJ-45 connector
Pinout	Please refer to Ethernet standard
Notes	LED Static ON: LAN Link is active. LED Blinking: Data is being transmitted. LED Static OFF: LAN Link is inactive

2.1.10 Reset Button



Item	Description
Location	S2
Type	Tact switch
Notes	To trigger system reset action

2.1.11 Recovery Button



Item	Description
Location	S1
Type	Tact switch
Notes	To trigger system reset action

2.1.12 Micro SD Card Slot

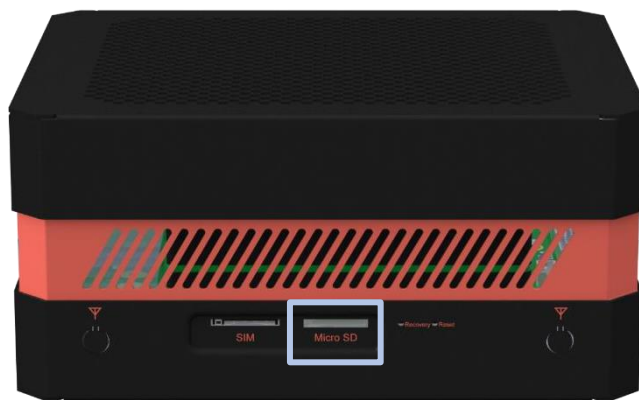

Item	Description
Location	CN5
Type	Push-Push Micro SD card holder

2.1.13 Micro SIM Card Socket

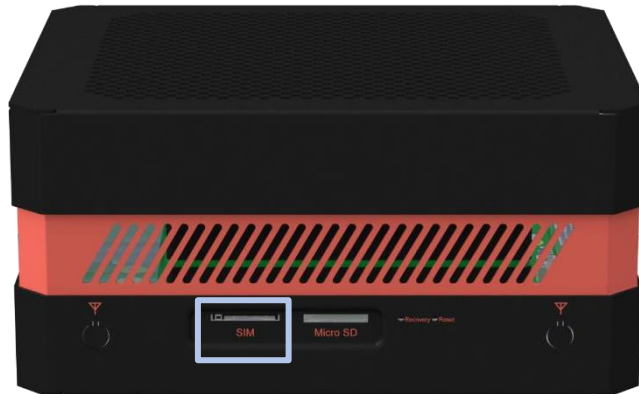

Item	Description
Location	CN6
Type	Push-Push SIM card socket

Chapter 3

Software Setup

This chapter introduces the following setup on the device:

(for advanced users only)

- Software/BSP Installation
- Recovery Mode

3.1 Software/BSP Installation

Note: This is for advanced users with the IBASE standard image file only.

IBASE NVIDIA Jetson products have built-in BSP so the users don't have to install it after getting the products. Since we develop our own BSP, the users may need to follow the BSP installation SOP to re-install/upgrade/downgrade the BSP. Please visit the IBASE website or contact with IBASE FAE for installation guides, BSPs and technical tips.

3.2 Recovery Mode

The OTG Type-C port of EC3500 can be connected to another host device (Linux PC running NVIDIA Jetpack™) to run recovery process for re-flashing BSP.

Note: Please backup user personal files before flashing process
Connect the OTG Type-C port to another host device which supplying updated BSP file.

Press and hold the Reset button, then press and hold the Recovery button continually.

After one second (1 sec.) release the Reset button first, then release the Recovery button.

The AGX Orin will show up as a new NVIDIA device on USB list (Terminal console) at the host device.

Running re-flashing BSP process can be executed by the host device now.

3.3 Initial Setup

Before using IBASE NVIDIA product series, please follow the steps below to have initial setup.

3.3.1 Prepare the materials

Please prepare the materials list below

- A monitor with HDMI and respective cables
- USB keyboard and mouse
- Ethernet cable

3.3.2 Hardware connection

ATTENTION: Jetson Orin module is not hot-pluggable. Before installing or removing the module, the main power supply (to Power connector, CN12) must be disconnected and adequate time allowed for the various power rails to fully discharge.

For the initial setup, users will need to connect LAN port, keyboard and mouse via USB interface, HDMI interface, and power connector.

3.3.3 Setup details

Step 1: Connect to the monitor while powering off

Step 2: Power on and automatically enter the OS

Step 3: Log in to the Ubuntu OS via credentials below

- Username: nvidia
- Password: nvidia

For more information on how to use Ubuntu and NVIDIA Jetson modules, please visit [Ubuntu](#) and [NVIDIA](#) website.